



GOODEE

 **Google TV**

USER MANUAL

Google TV is the name of this device's software experience and a trademark of Google LLC. Google, YouTube and Google Home are trademarks of Google LLC.

Manufactured under license from Dolby Laboratories. Dolby, Dolby Audio and the double-D symbol are trademarks of Dolby Laboratories Licensing Corporation.

The terms HDMI, HDMI High-Definition Multimedia Interface, HDMI Trade dress and the HDMI Logos are trademarks or registered trademarks of HDMI Licensing Administrator, Inc.

Nefflix is a trademark of Nefflix, Inc.

All brands contained herein are trademarks of their respective owners.

 <https://www.goodee-us.com/>

 support@goodee-us.com

 (855)522-0987

 Mon. – Fri. 9:00 AM-5:00 PM (PT)



SCAN ME

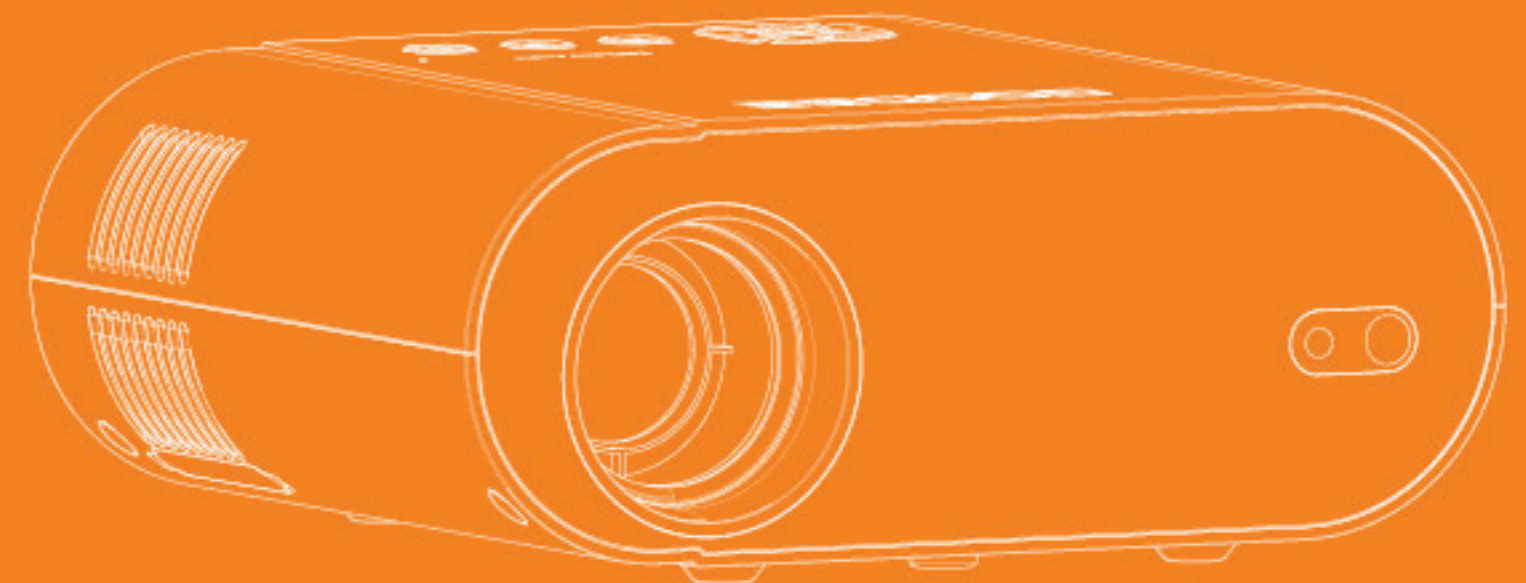

MODEL NO.

GD500 PLUS

FCC-ID: 2AVE7-L007

Projector Installation

Place your projector on the ceiling

1. When installing the projector on the ceiling, please purchase a projector bracket recommended by an installation professional and follow the instructions supplied with the bracket.
2. Before installing the projector on the ceiling, please check if the mounting structure can support the weight of the projector and the bracket. If in doubt, please consult the advice of an installation.

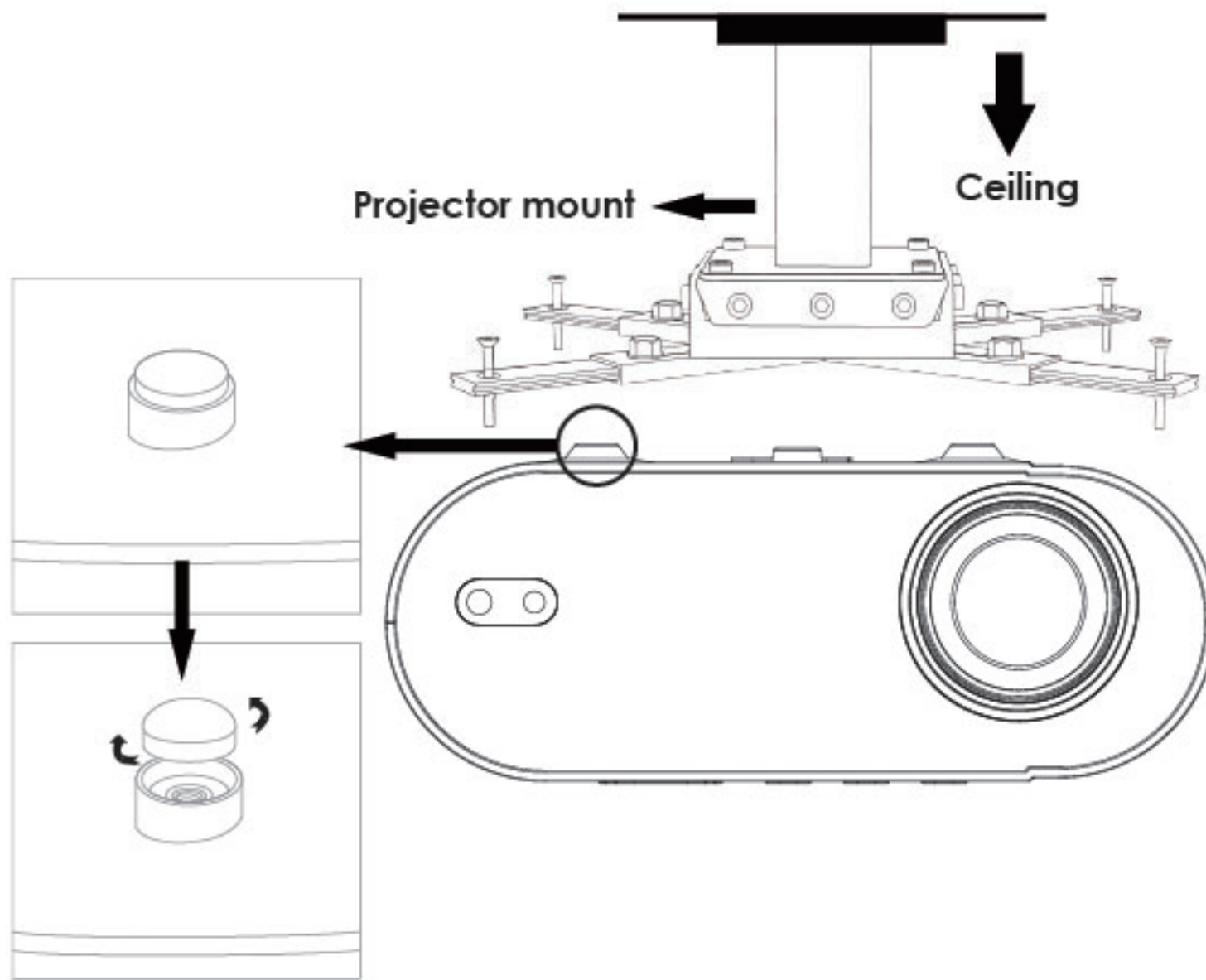

Fixed Hanger Screw Hole Type: 1/4-20 screws * 4.

NOTE: Projector bracket and screw (s) are not included.

Technology Features

a. Parameters

Product Model	GD500 PLUS	Integrated Watt	90W
Image System	TFT LCD	Light Source	LCD
Native Resolution	1920 * 1080 Pixels	Aspect Ratio	16 : 9
Projection Mode	Front / Rear / Ceiling	Keystone	±15°Correction
Speaker	4Ω 5W	Power	AC 100 - 240V
Input	AV*1、USB*2、HDMI*1	Output	Audio*1
Size	234*191*95mm	Wi-Fi Frequency Band	2.4G / 5G
Weight	1.45KG		

b. Projection Distance and Screen Size

Recommended Projection Distance: 4.3-16.4 Feet

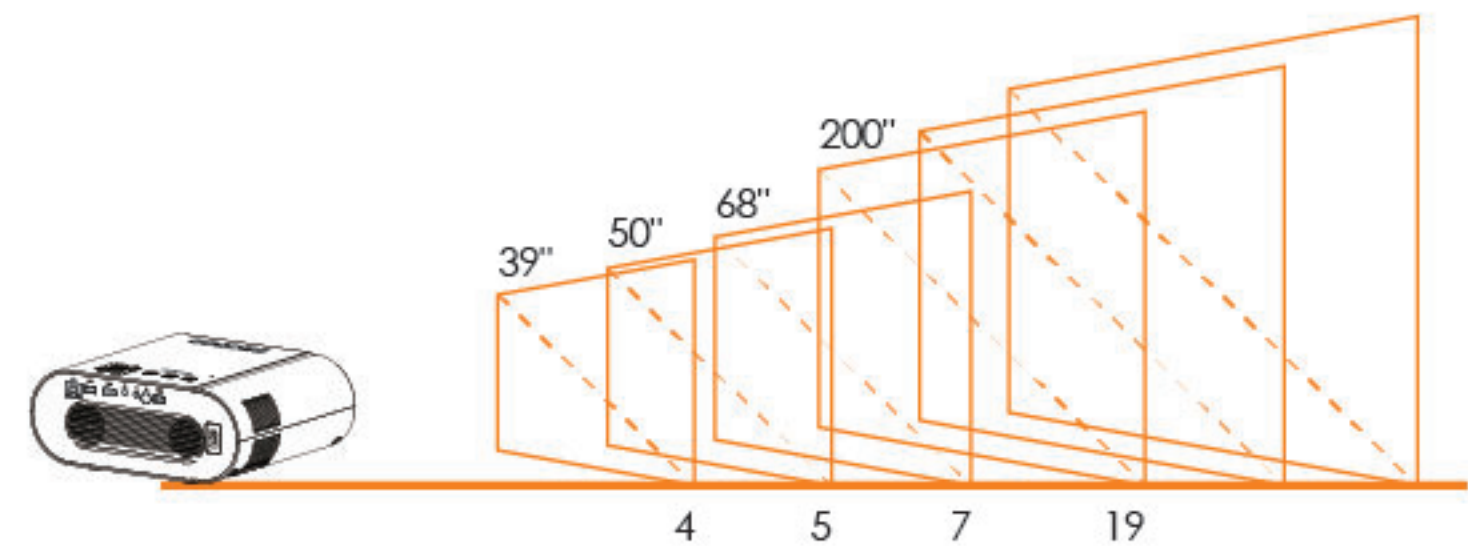

NOTE: Because the optical device has about 3% error, the above data is for reference only, please install the projector according to the actual measurement. (ft)

24/7 LIVE CHAT SUPPORT

ACTIVATE YOUR 12-MONTH WARRANTY & CUSTOMER SERVICE

by choosing one of the following two options:

Option 1

Please visit our website and register:

 <https://www.goodee-us.com/>

Option 2

Remote Tech Support (Us Based)

Speak with Support  (855)522-0987

 support@goodee-us.com

(English) **CATALOG**

Safety Instructions.....	1
Package List.....	5
Overview.....	6
Remote Control	7
Getting Started	8
Connections	9
Power On and Initial Setup	09
Other Settings	14
Projector Installation.....	17
Technology Features.....	18

Safety Instructions

Read all instructions before you use this device. Do not make any changes or create settings that are not described in this manual. If physical injury, loss of data or damage is caused by failure to follow instructions, the warranty does not apply.

Setup

1. To reduce the risk of fire or electric shock, do not expose the device to rain or moisture. Objects filled with liquids, such as vases, should not be placed on this device.
2. Do not place this device on soft surfaces such as tablecloths or carpets, otherwise the device could be a fire hazard.
3. Do not place this device in areas susceptible to excessive dust and dirt or near any appliance generating a strong magnetic field.
4. To prevent overheating, do not block or clog the ventilation openings.
5. Never place this device in a confined space. Leave enough space around this device for ventilation.
6. Protect this device from overexposure to direct sunlight, heat, large temperature fluctuations and moisture. Avoid extreme temperatures. The suitable operations and storage temperature for this device and its accessories is (0°F to 95°F).
7. When this device is running for a long period of time, the surface may become hot. Shut it down immediately and unplug the charger. Resume operation after this device has cooled down.
8. Always handle this device with care. Avoid touching the lens. Do not allow children to handle the device without supervision.
9. Never place heavy or sharp objects on this device.
10. To avoid electric shock, do not disassemble.
11. Use attachments or accessories specified by the manufacturer only.
12. Avoid extreme vibrations as they may damage the internal components.

The following safety instructions ensure the long service life of the projector to avoid fire or electric shock. Please read carefully and pay attention to the following warnings.

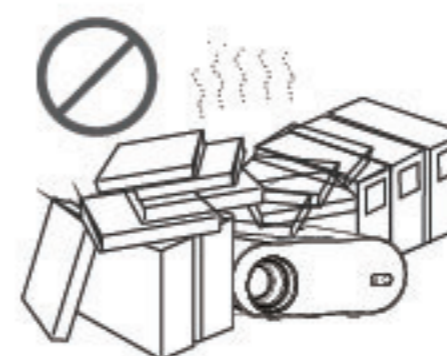

Don't install the projector in sites with improper ventilation.



Don't install the projector in hot or humid sites.



Don't cover the projector ventilation holes with any material.



Don't install the projector in dust or smoke sites.



Don't install the projector near the temperature or smoke transducer. It may cause a sensor failure.



Don't install the projector in sites with direct blowing of warm or cool air-condition wind.



Please do not look into the lens when the projector is working, otherwise it may hurt your eyes.



Please keep the projector away from water or any other liquid as it is not waterproof.

● Notice

- (1) Please use the power cord with caution to avoid unduly bending. Damaged power cord may cause electric shock.
- (2) Please use the projector with caution to avoid dropping or shocking, which may damage the internal components.
- (3) Please use the same power voltage as marked on the projector.
- (4) Please use the projector in a dark room for best results.
- (5) Please do not disassemble the projector by yourself, otherwise the warranty will be void.
- (6) Please turn off and unplug from the power supply if not using the projector for a long time.

● FCC Statement

Radiation Exposure Statement.

This device complies with part 15 of the FCC rules. Operation is subject to the following two conditions:

(1) This device may not cause harmful interference, and (2) this device must accept any interference received, including interference that may cause undesired operation.

Changes or modifications not expressly approved by the party responsible for compliance could void the user's authority to operate the equipment.

This equipment complies with FCC radiation exposure limits set forth for an uncontrolled environment.

This equipment should be installed and operated with minimum distance 20cm between the radiator and your body.

This transmitter must not be co-located or operating in conjunction with any other antenna or transmitter.

NOTE: This equipment has been tested and found to comply with the limits for a Class B digital device, pursuant to part 15 of the FCC Rules. These limits are designed to provide reasonable protection against harmful interference in a residential installation. This equipment generates uses and can radiate radio frequency energy and, if not installed and used in accordance with the instructions, may cause harmful interference to radio communications. However, there is no guarantee that interference will not occur in a particular installation.

If this equipment does cause harmful interference to radio or television reception, which can be determined by turning the equipment off and on, the user is encouraged to try to correct the interference by one or more of the following measures:







- Reorient or relocate the receiving antenna.
- Increase the separation between equipment and receiver.
- Connect the equipment into an outlet on a circuit different from that to which the receiver is connected.
- Consult the dealer or an experienced radio/TV technician for help important announcement Important.

● Radiation Exposure Statement

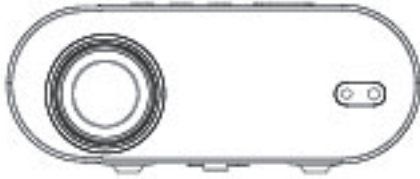
This equipment complies with FCC radiation exposure limits set forth for an uncontrolled environment. This equipment should be installed and operated with minimum distance of 20cm between the radiator and your body.

This transmitter must not be co-located or operating in conjunction with any other antenna or transmitter.

Package List

		
Projector × 1	Power Cable × 1	HDMI Cable × 1
		
Remote Control × 1 (Batteries are not included)	Lens Cover × 1	Lens Cover × 1
		
Projector User Manual		

Tips:

1. Blurry Image

- * First, wait for the projector to automatically keystone correct to a rectangular shape.
- * Second, use the remote control focus adjustment function for optimal sharpness.
- * Optimum projection distance: 4.26-16.4 ft.

2. Mounting Hole

Adopting a single mounting hole dual-use design, the projector is compatible with the standard camera tripod and 3/16 inch screw projector tripod stand. Meanwhile, you can rotate 360° the screw to meet different angle needs.

Overview

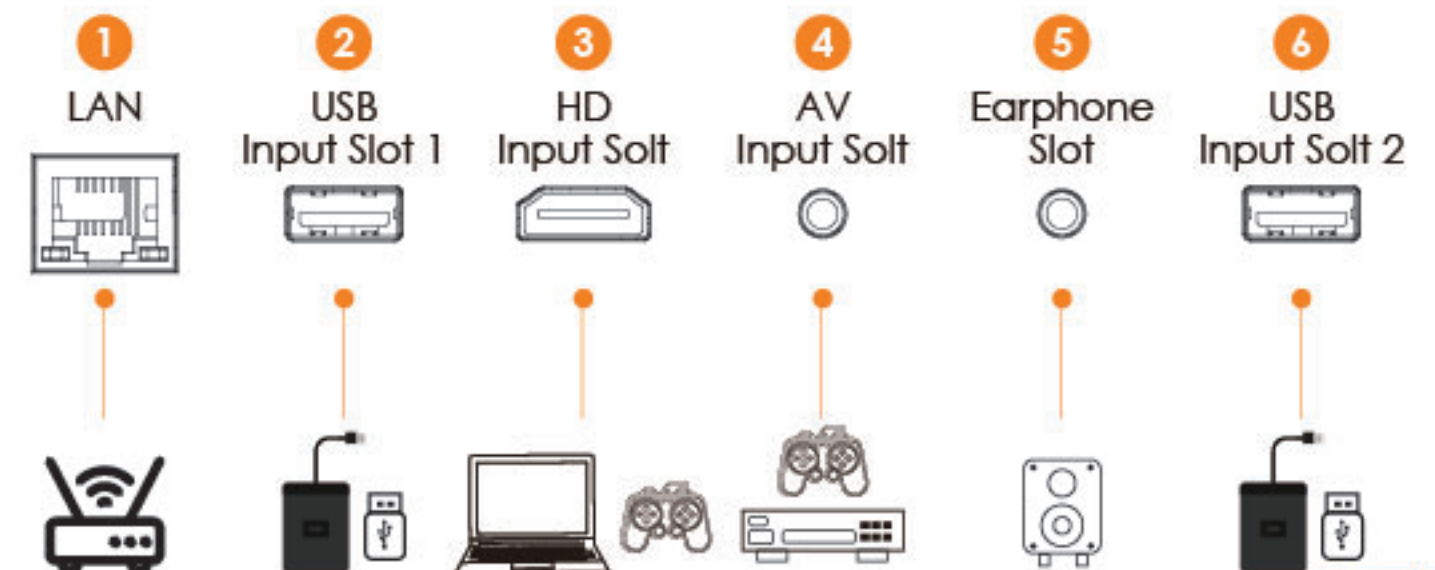
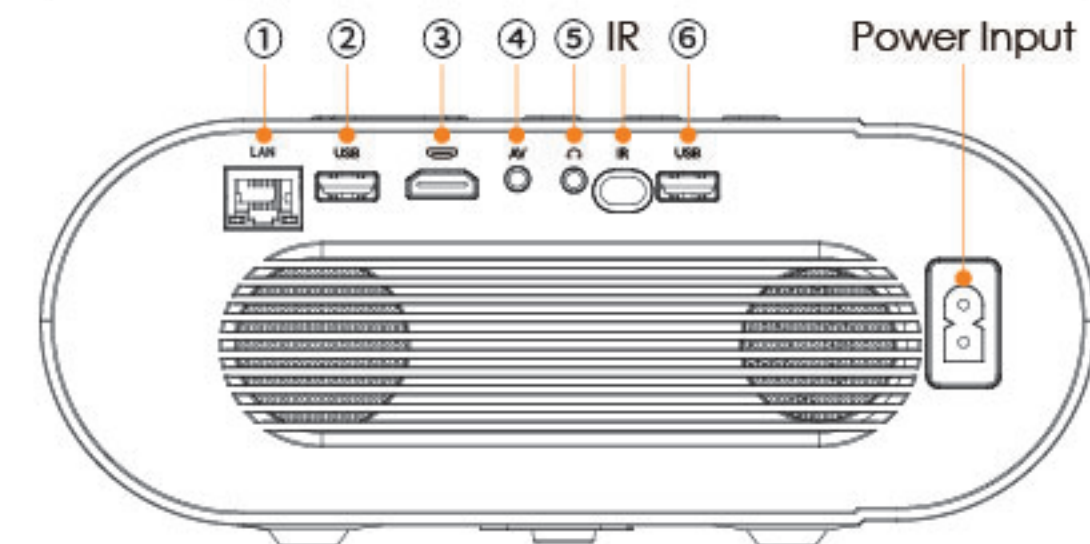
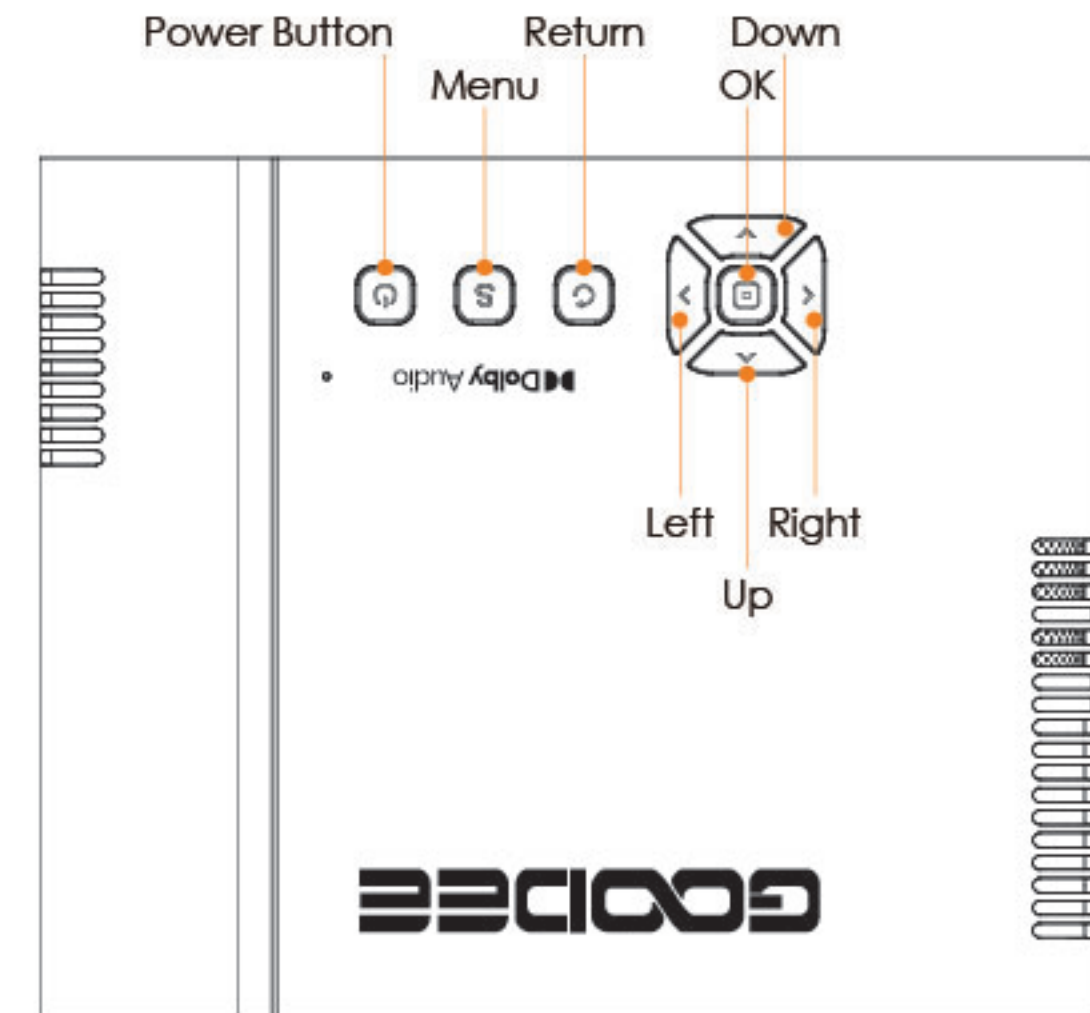

Remote Control

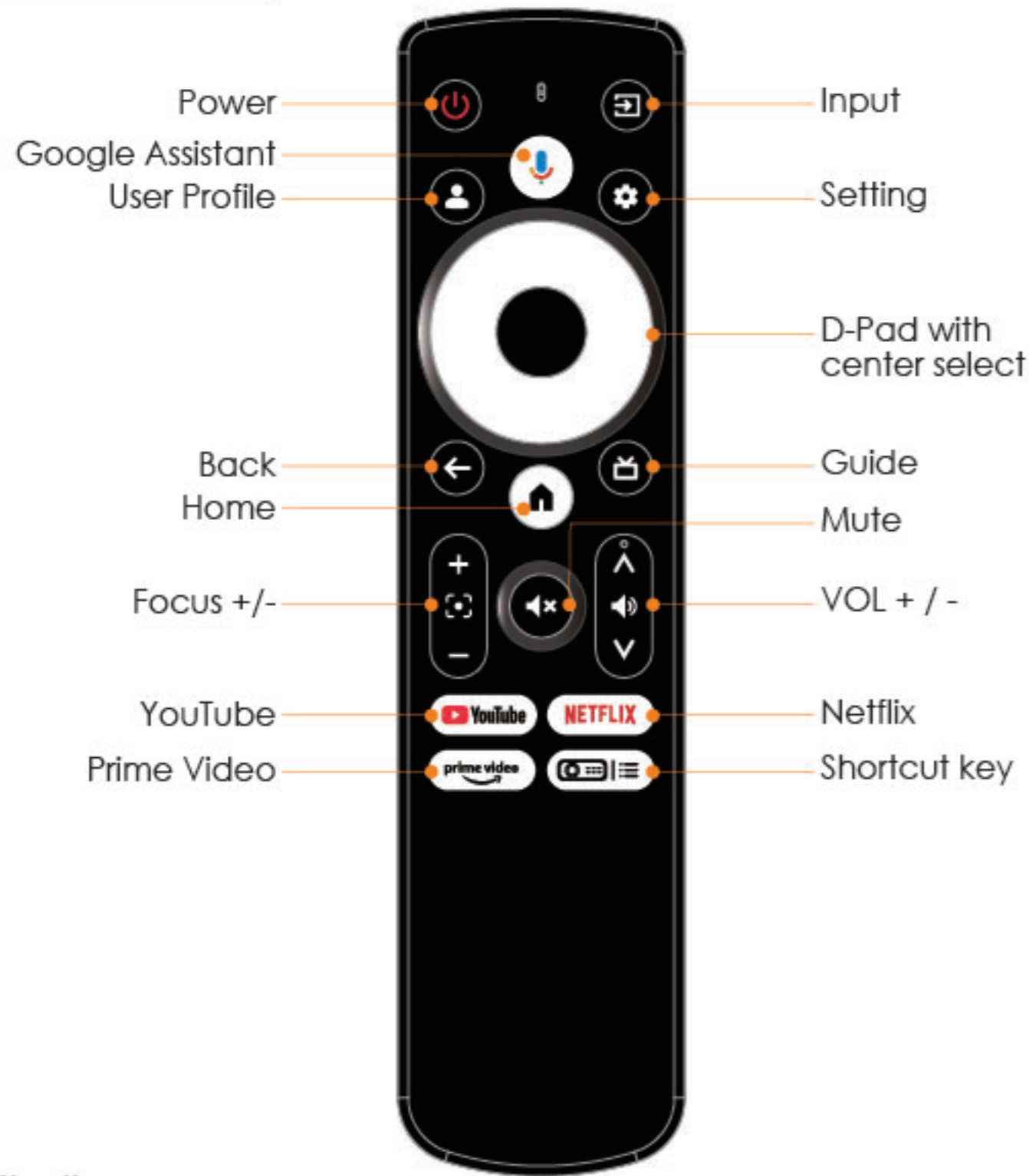

Attention:

1. Do not submerge the remote control in water.
2. Do not put the remote control near fire or in wet or hot places.
3. Do not use old and new batteries together in the remote control.
4. Please take the batteries out if not using the remote control for a long time to avoid battery leakage.
5. Please point the remote control toward the IR receiver.
6. Please use the remote control within 6 meters distance and 30 degree angle.
7. If this part is missing, please contact our customer service email address in the Quick start guide or contact the seller you bought this device.

Getting Started

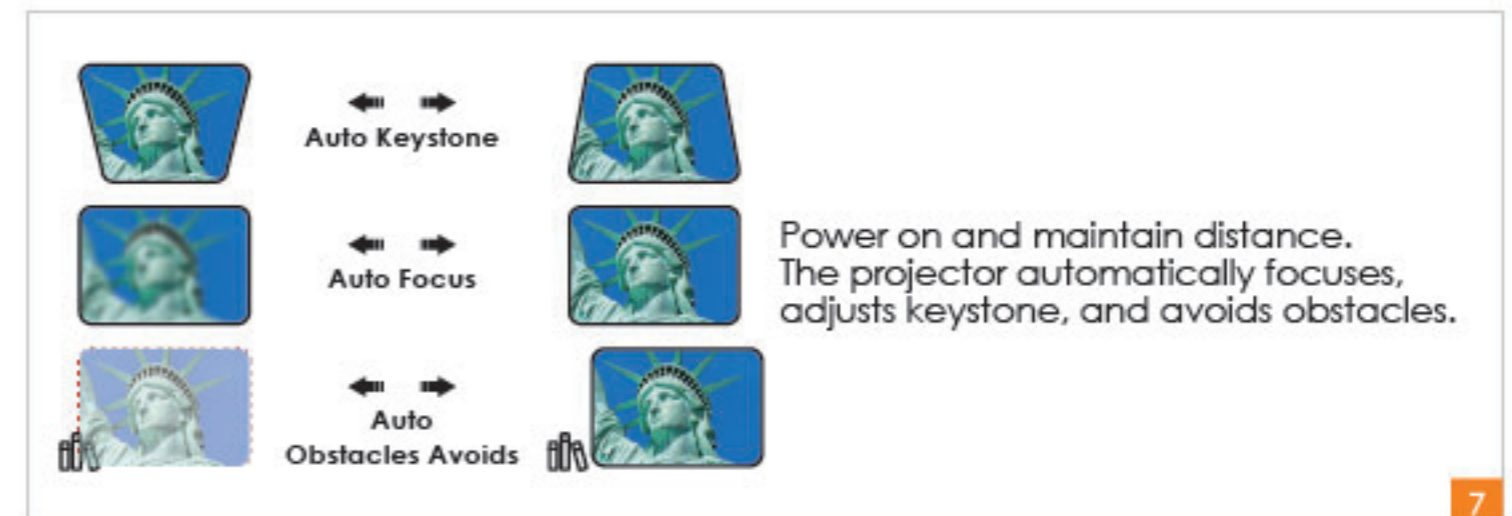
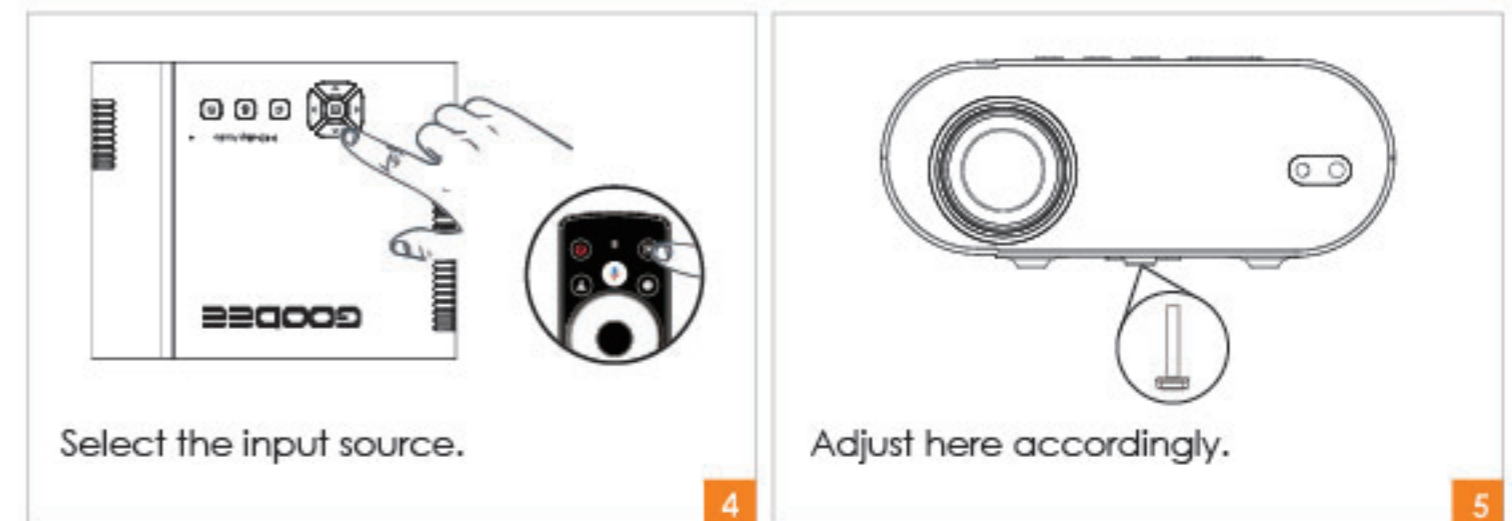
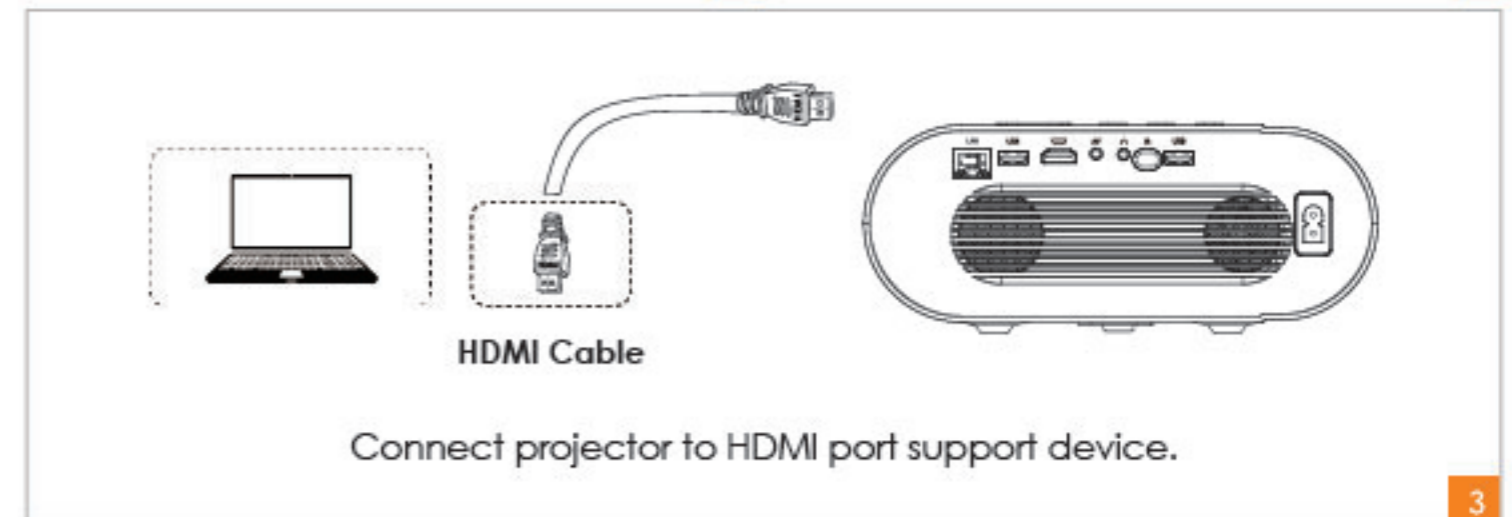

Power On and Initial Setup

• Step 1

Plug in the power cord and connect the projector to a power source.

- Press the power button located on the projector.
- The projector will start initializing and display the startup screen.

• Step 2

Follow the on-screen instructions to pair the remote control with the projector.

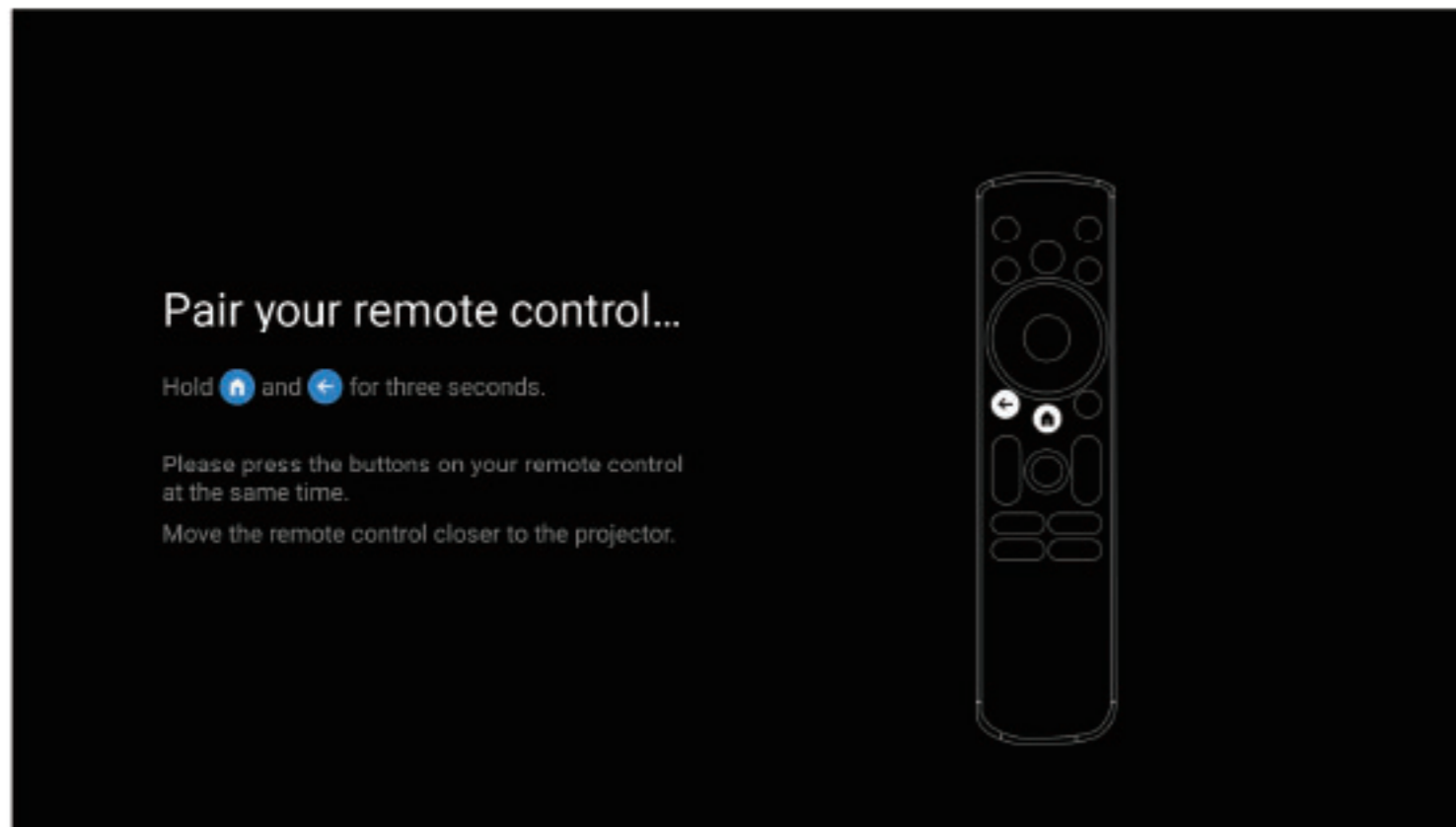

• Step 3

Set your language and country (language can be changed anytime after the initial setup).

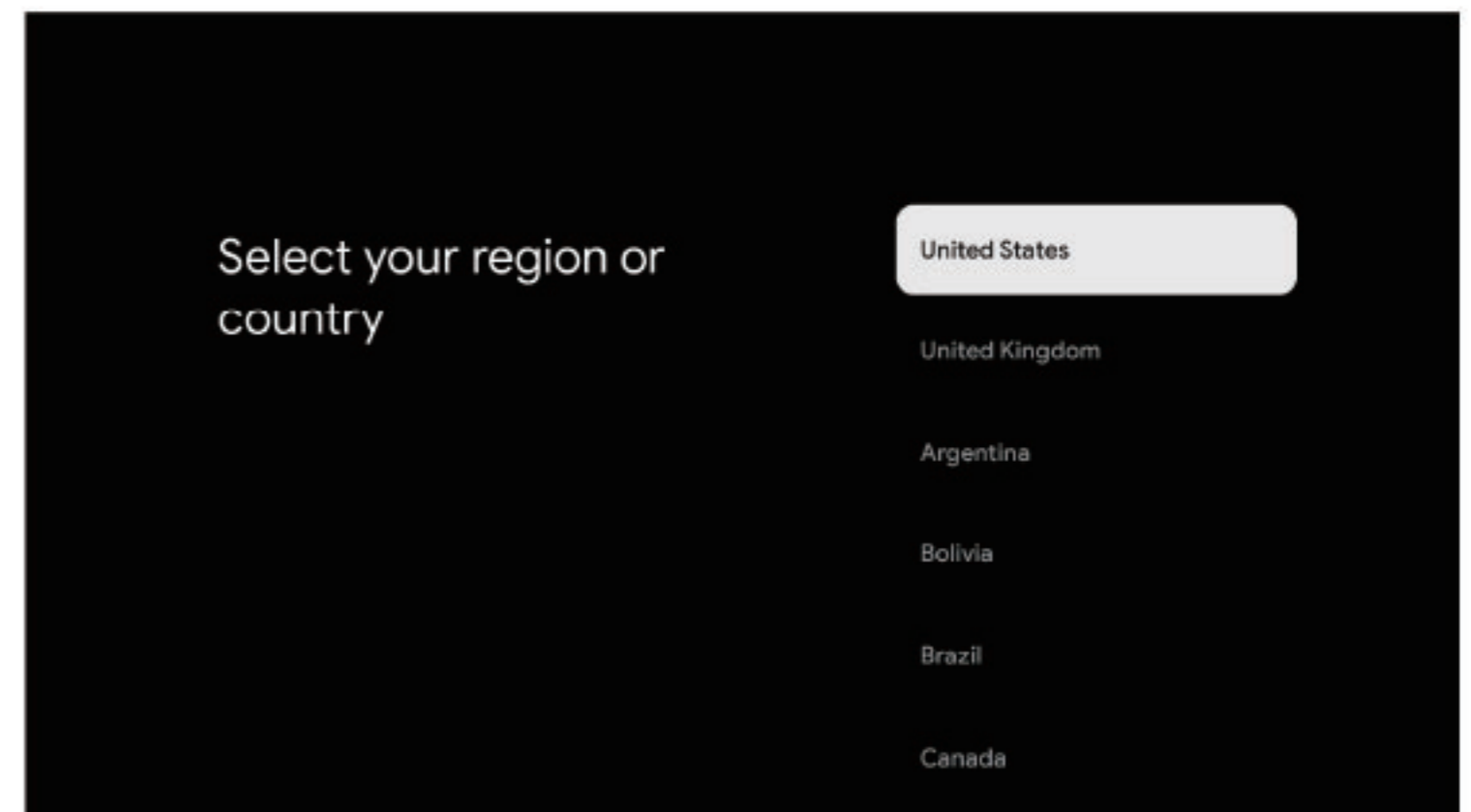
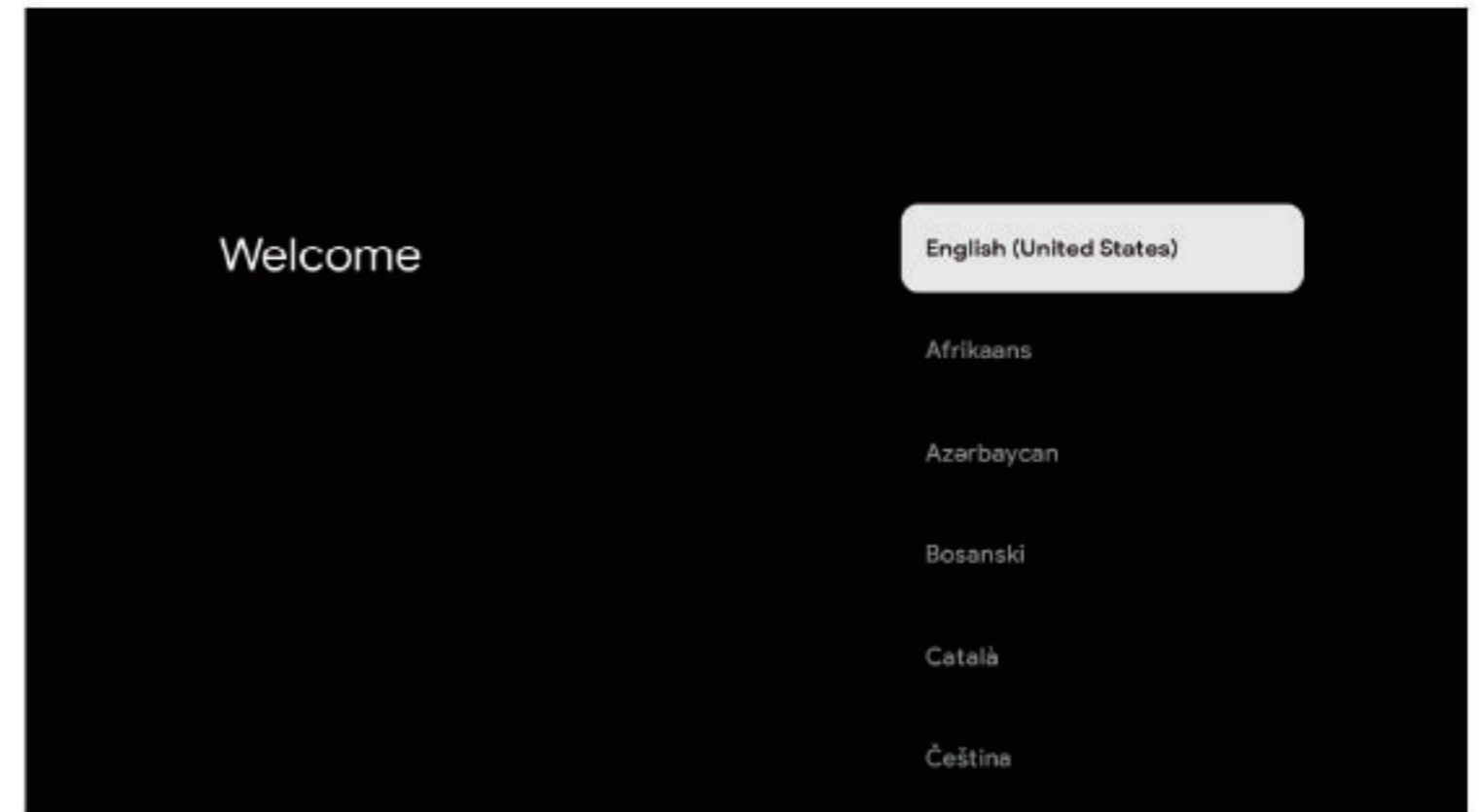

• Step 4

Set up Google TV™ and set up with the Google Home app. (May take longer. Requires typing with the remote.)

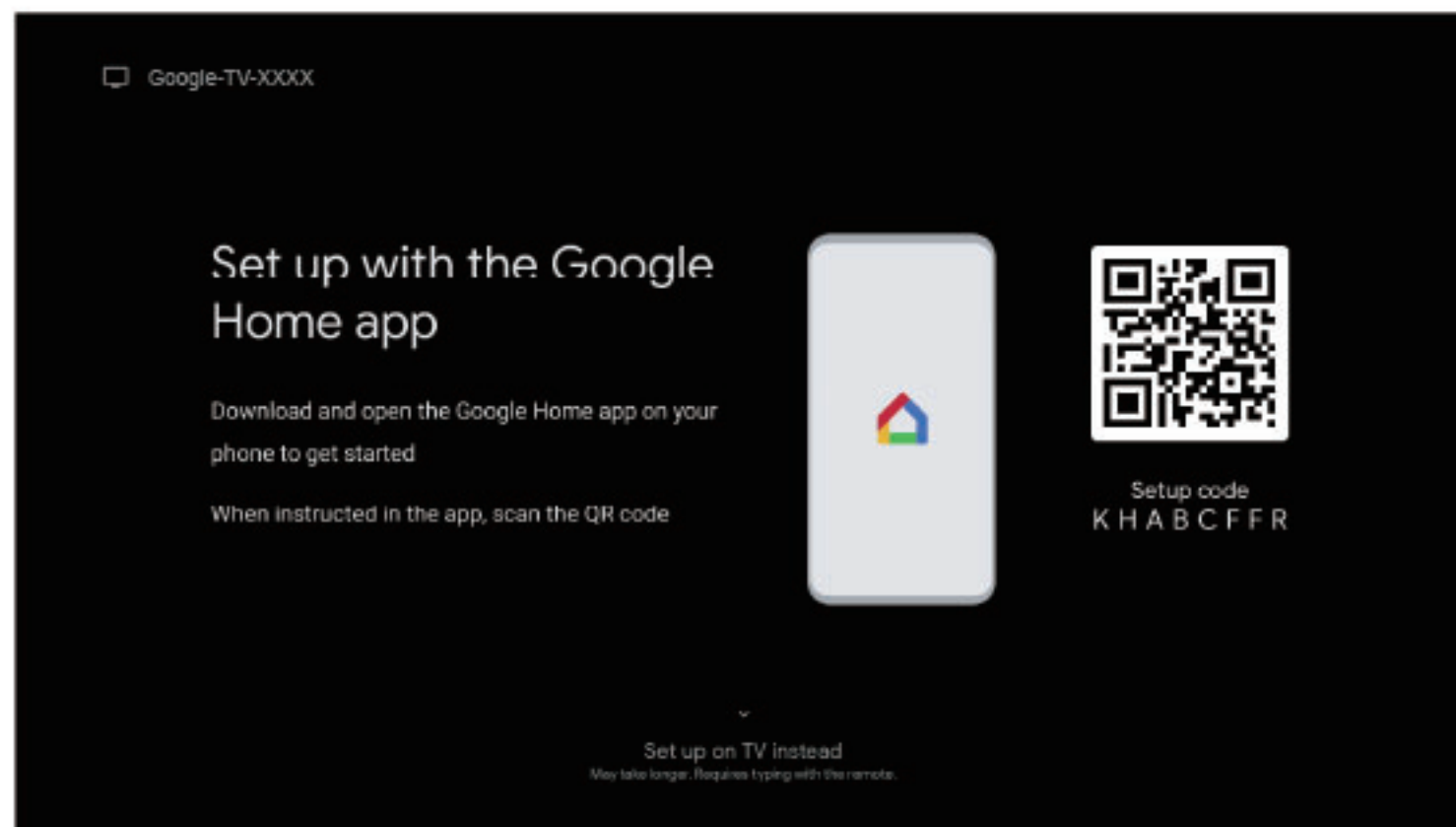
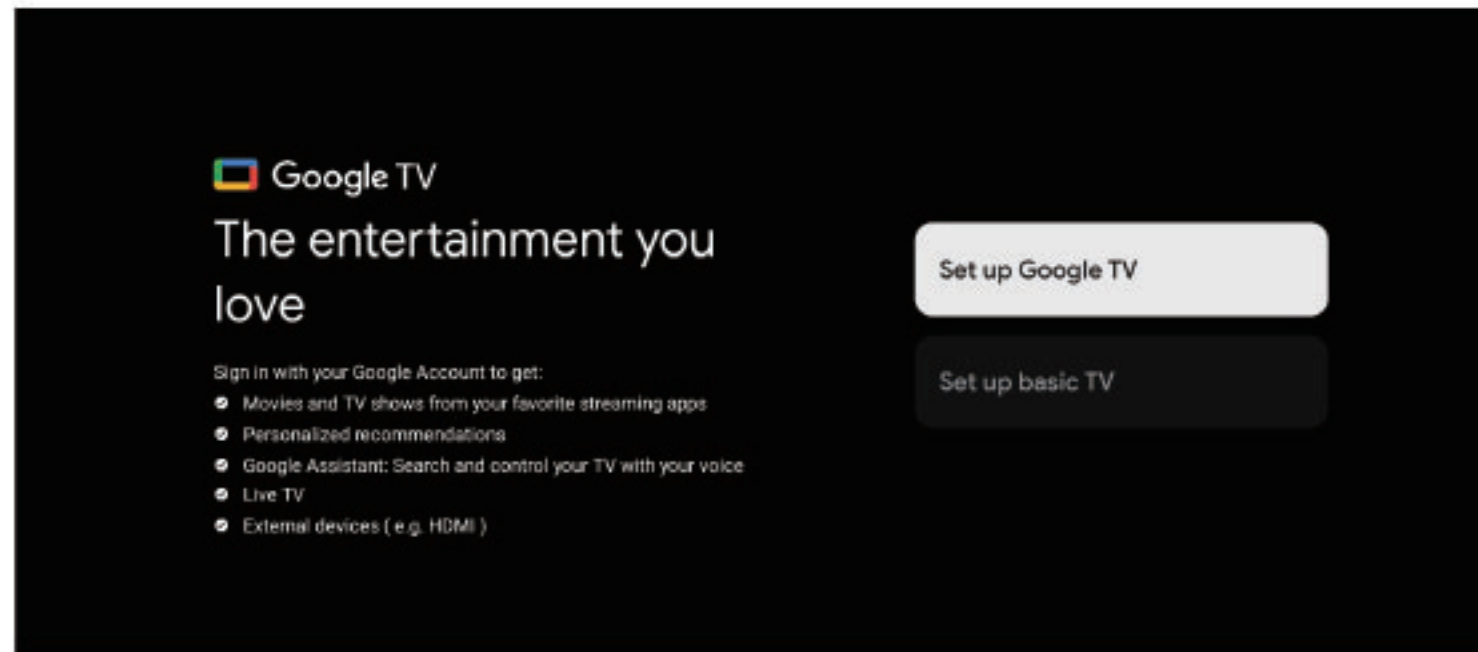

• Step 5

Select your Wi-Fi network and wait for the connection to be established successfully.

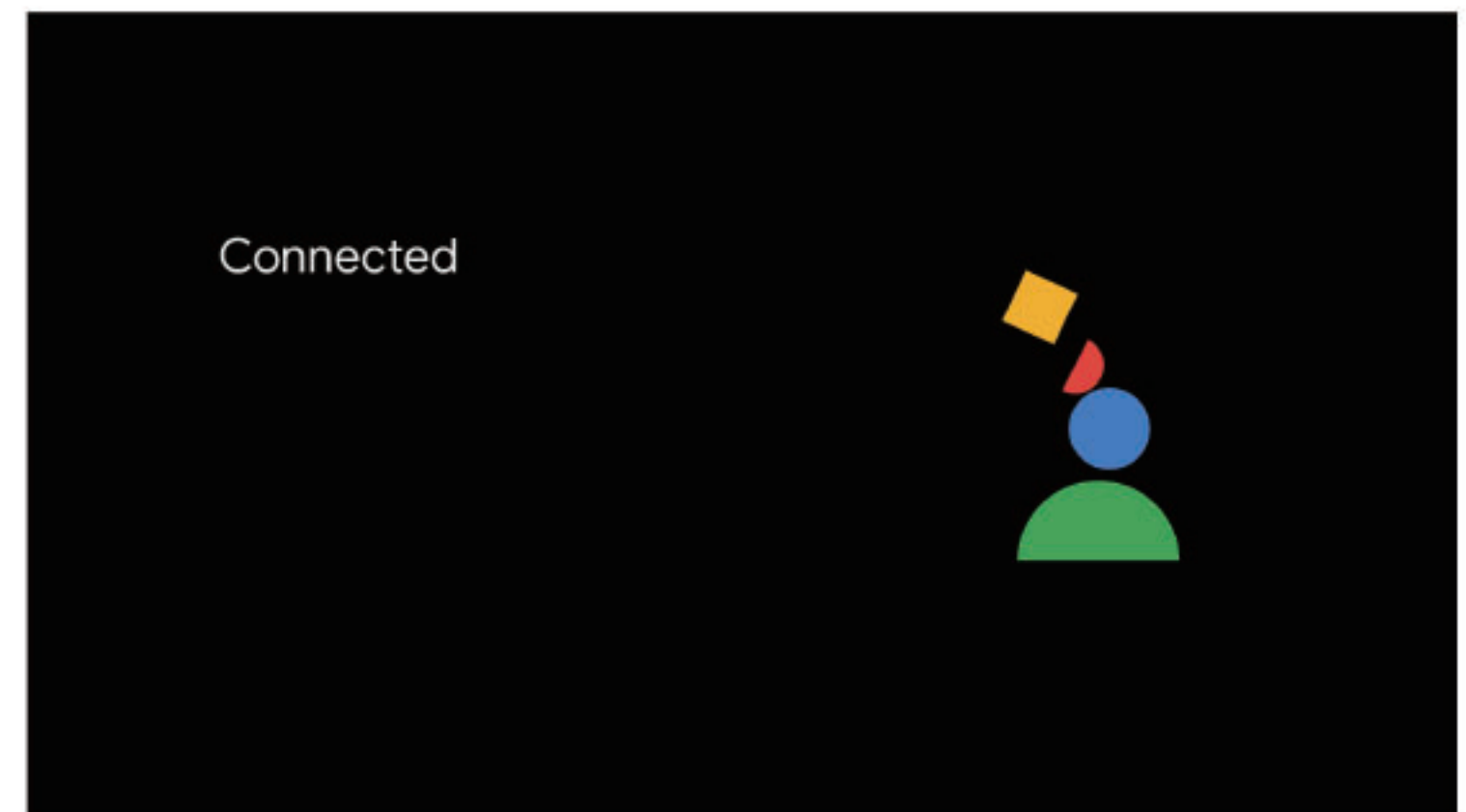
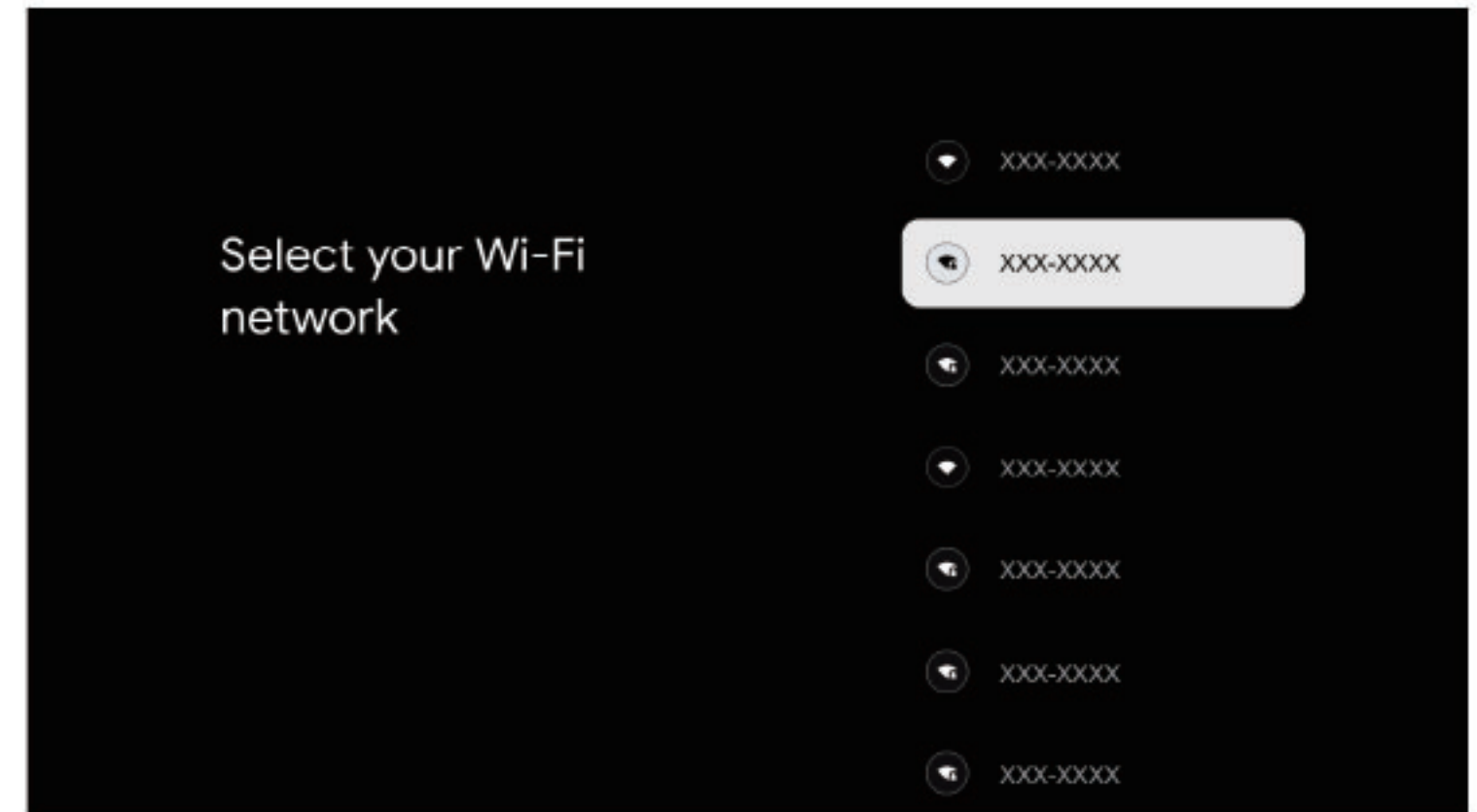

• Step 6

Click "Accept".

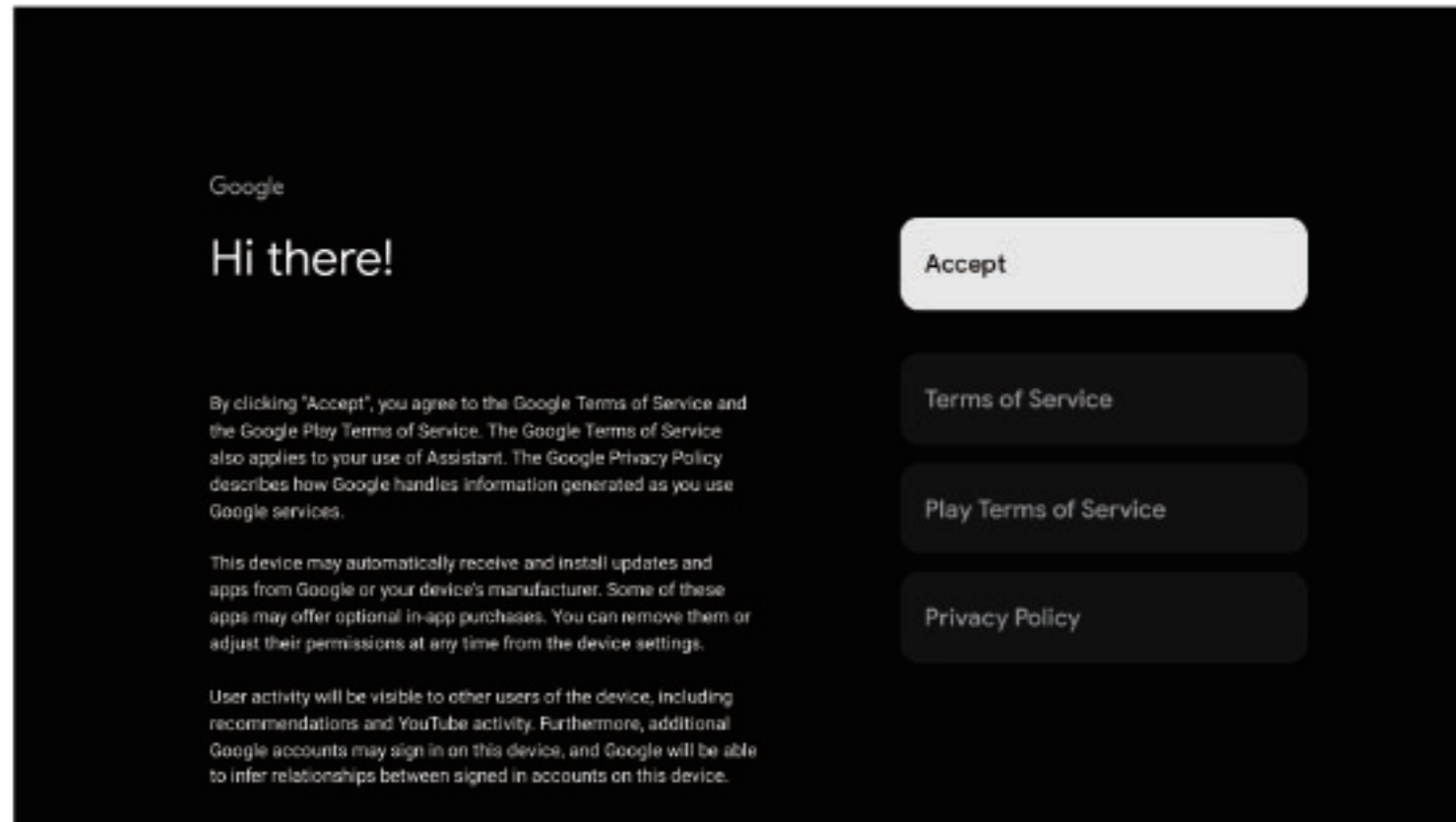

Congratulations! You can now begin your movie-watching journey!

Other Settings

• Settings

You can access it by clicking the gear icon in the top right corner of the dashboard or by pressing the "⚙️" button on the remote control.

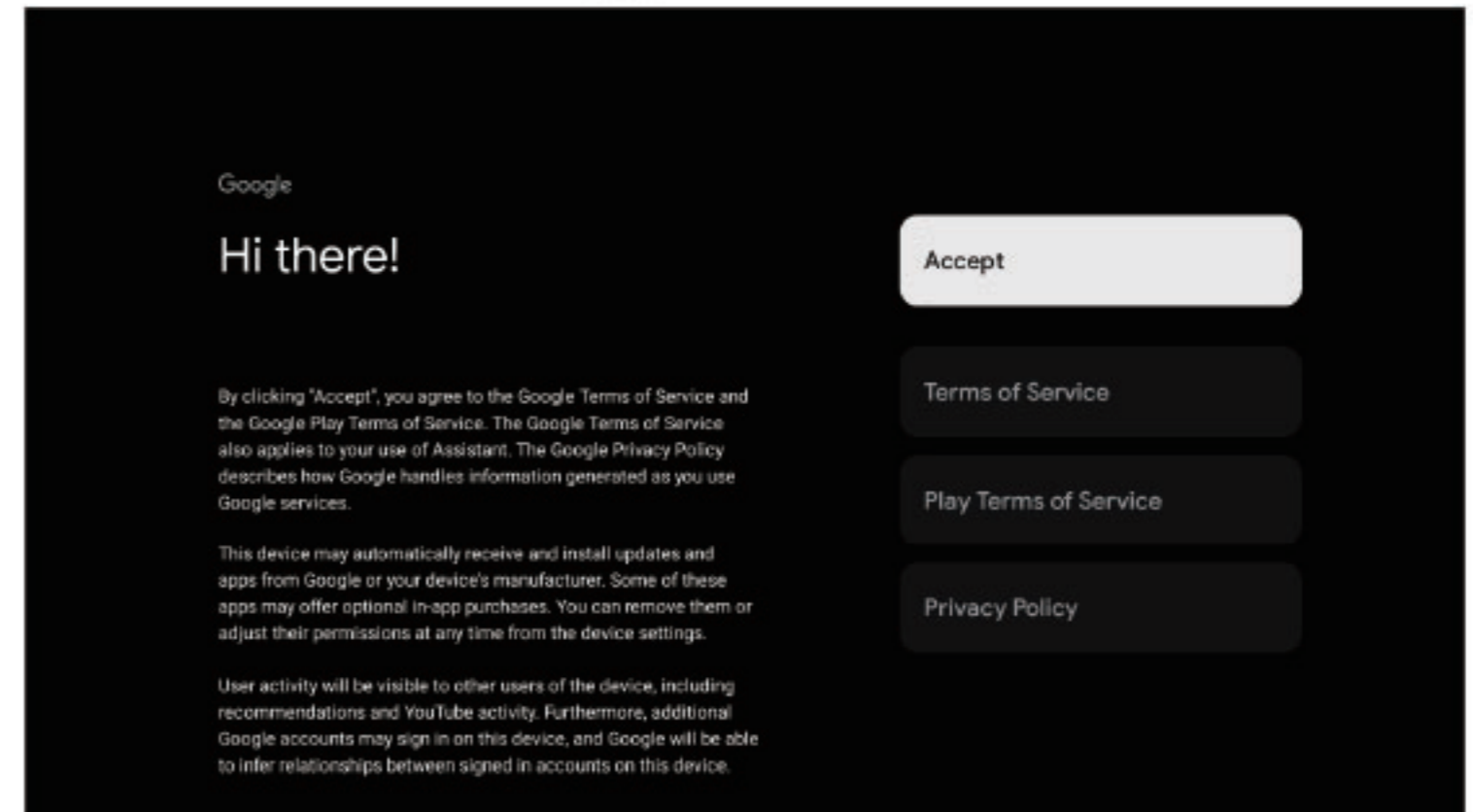

You can manage your Google Account on this interface.

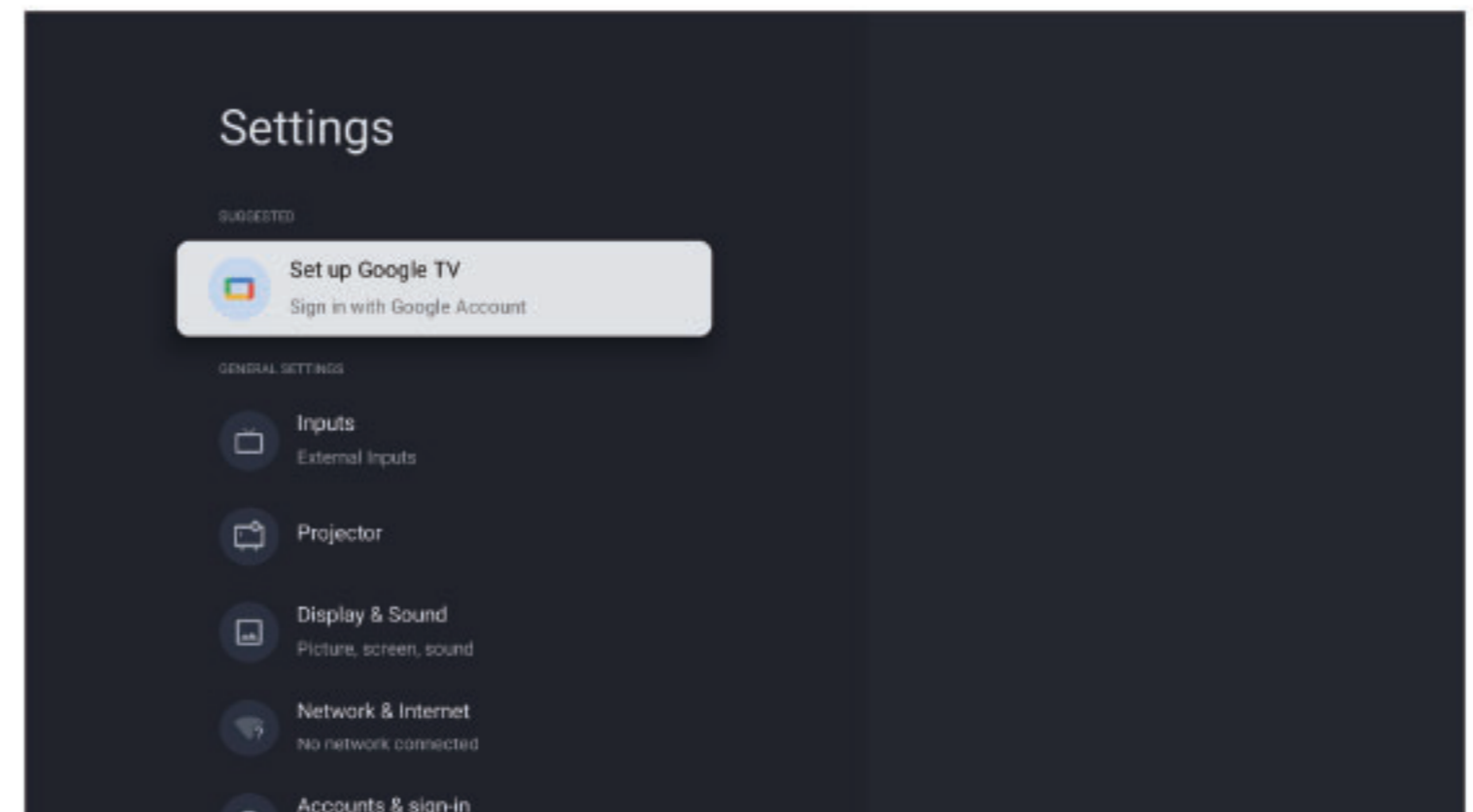

• Projector Settings

By clicking on the "Projector" option in the menu or using the "📽️" button on the remote control, you can access the projector settings page.

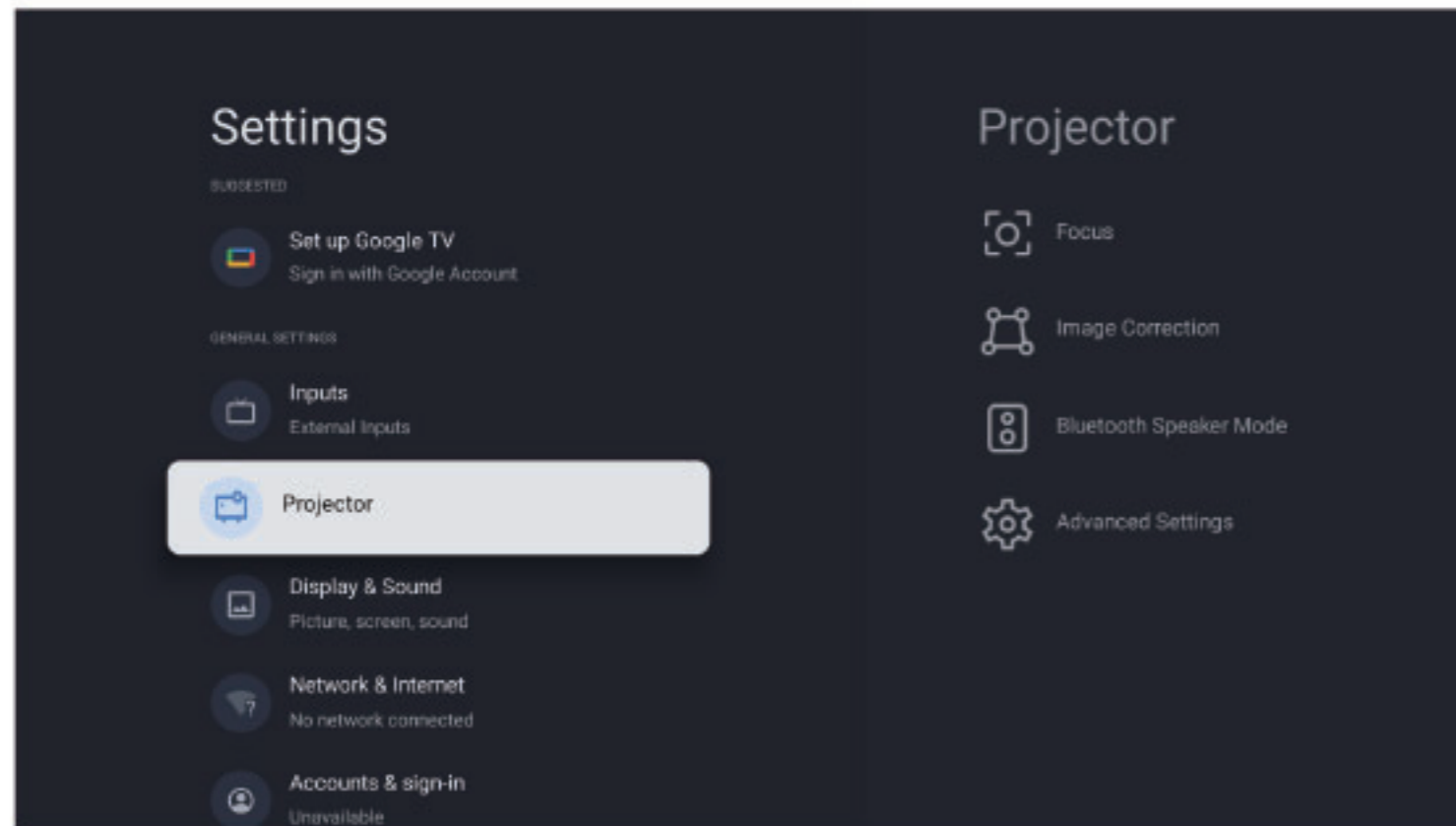

• Bluetooth Speaker Mode

Bluetooth speaker mode is being opened, 10s after entering the screen off state. Press and hold the "⏪" button for 2s to exit.

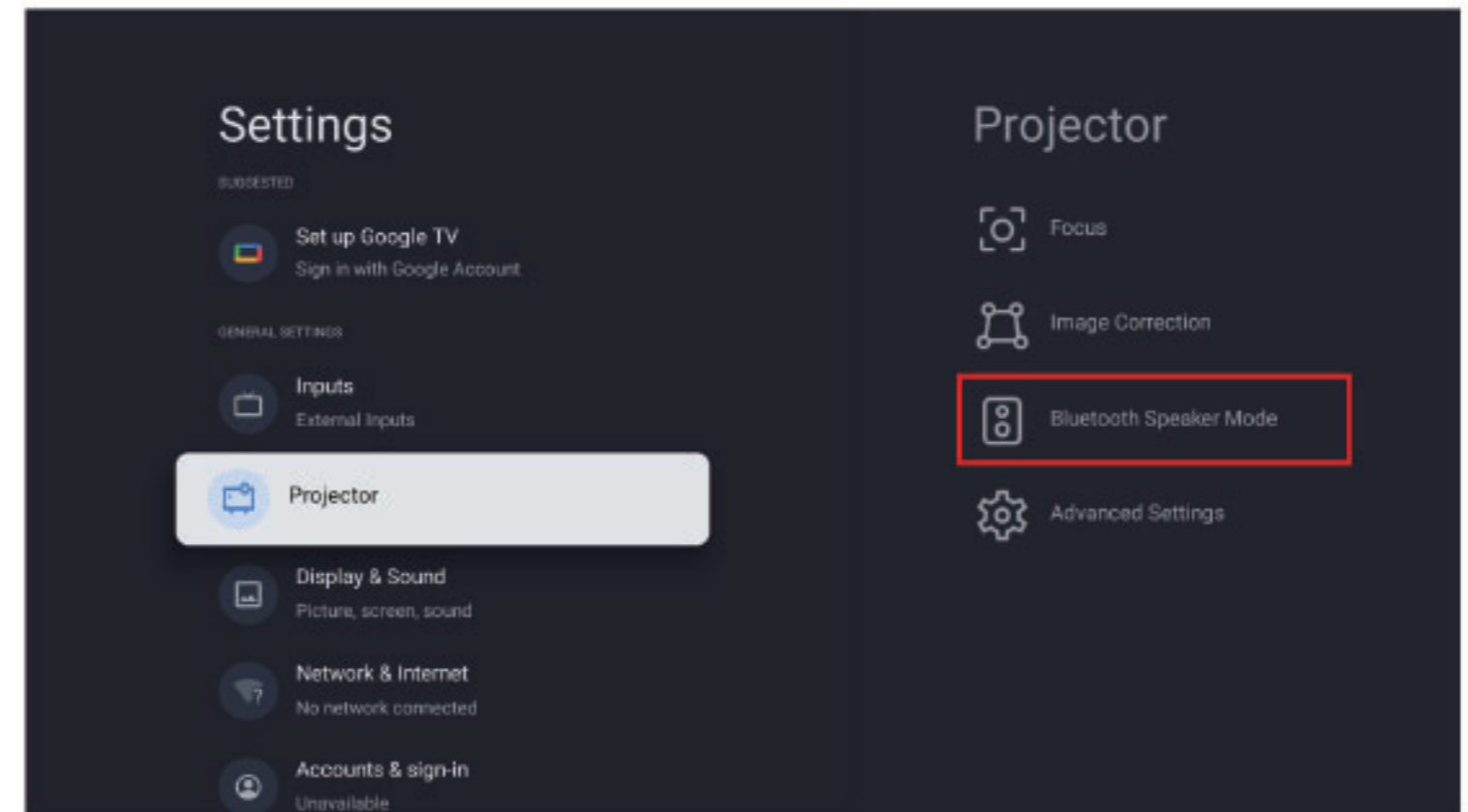

• Network Settings

You can change and manage your Wi-Fi network here.

